

KENWOOD

STEREO POWER AMPLIFIER

KM-992

INSTRUCTION MANUAL

KENWOOD CORPORATION

B60-0803-00 (K, P, M, X, Y) GA

Introduction

Your choice of this product indicates that you are a devotee to excellence in sound reproduction.

We appreciate your patronage and take pride in the long tradition of quality components that our company represents.

So that you can get the most out of your unit, we suggest that you take the time to read through this manual before you hook up and operate your system. This will acquaint you with operating features and system-connection considerations so that your listening pleasure will be enhanced right from the start. You will notice that in all aspects of planning, engineering, styling, operating convenience and adaptability we have sought to anticipate your needs and desires.

Keep this manual handy for future reference.

For your records

Record the serial number, found on the back of the unit, in the spaces designated on the warranty card, and in the space provided below. Refer to the model and serial numbers whenever you call upon your dealer for information or service on this product.

Model _____ Serial Number _____

Unpacking

Unpack the unit carefully and make sure that all accessories are put aside so they will not be lost.

Examine the unit for any possibility of shipping damage. If your unit is damaged or fails to operate, notify your dealer immediately. If your unit was shipped to you directly, notify the shipping company without delay. Only the consignee (the person or company receiving the unit) can file a claim against the carrier for shipping damage.

We recommend that you retain the original carton and packing materials for use should you transport or ship the unit in the future.

Accessory

AC plug adaptor1
(except for some areas)
For the unit with a European AC
plug in areas other than Europe.

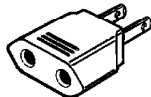

Contents

Caution: Read the pages marked  carefully to ensure safe operation.

Introduction	2	Controls and indicators	8
⚠ Before applying power	3	Operating instructions	9
⚠ Safety precautions.....	3	Listening to the program source	9
⚠ IMPORTANT SAFEGUARDS	4	Listening through headphones	9
System connections	6	POWER LEVEL METER	9
To AC outlets.....	6	In case of difficulty	10
Connection of speakers.....	7	⚠ Specifications	11
Setting the SPEAKER IMPEDANCE SELECTOR	7		

Before applying power

Caution: Read this page carefully to ensure safe operation.

For the U.S.A. and Canada

Important!

Units shipped to the U.S.A. and Canada are designed for operation on 120 volts AC only.

CAUTION: TO PREVENT ELECTRIC SHOCK DO NOT USE THE AC PLUG WITH AN EXTENSION CORD, RECEPTACLE OR OTHER OUTLET UNLESS THE BLADES CAN BE FULLY INSERTED TO PREVENT BLADE EXPOSURE.

For the United Kingdom

Important!

Units shipped to the U.K. are designed for operation on 240 volts AC only.

The mains plug must be removed from the wall socket prior to any internal examination.

The wires in this mains lead are coloured in accordance with the following code.

- Blue.....Neutral
- Brown.....Live

The wires in this mains lead must be connected to the terminals in the plugs as follows:

- | | |
|--------------------|------------------------------|
| Wire colour | Plug terminal marking |
| Blue..... | N or Black |
| Brown..... | L or Red |

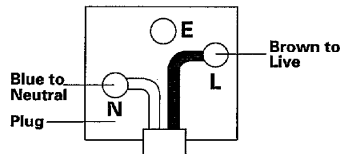

- Notes:**
- If a 13-amp plug is used, this must be fitted with a 5-amp fuse.
 - If a 3-pin plug with earthing contact is used, no wire must be connected to the E terminal.

For Australia and Europe

Important!

Units shipped to Australia are designed for operation on 240 V AC only.

Units shipped to Europe are designed for operation on 230 V AC only.

For other countries

Important!

Units shipped to countries other than the above countries are equipped with an AC voltage selector switch on the rear panel. Refer to the following paragraph for the proper setting of this switch.

AC voltage selection

This unit operates on 110 – 120 or 220 – 240 volts AC. The AC voltage selector switch Type A or Type B on the rear panel is set to the voltage that prevails in the area to which the unit is shipped. Before connecting the power cord to your AC outlet, make sure that the setting position of this switch matches your line voltage. If not, it must be set to your voltage in accordance with the following direction.

Note: Our warranty does not cover damage caused by excessive line voltage due to improper setting of the AC voltage selector switch.



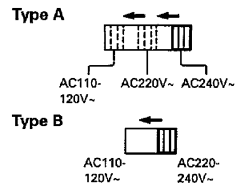

AC voltage selector switch



Move switch lever to match your line voltage with a small screwdriver or other pointed tool.

Safety precautions

WARNING: TO PREVENT FIRE OR ELECTRIC SHOCK, DO NOT EXPOSE THIS APPLIANCE TO RAIN OR MOISTURE.

	<p>CAUTION RISK OF ELECTRIC SHOCK DO NOT OPEN</p> 	<p>CAUTION: TO REDUCE THE RISK OF ELECTRIC SHOCK, DO NOT REMOVE COVER (OR BACK). NO USER-SERVICEABLE PARTS INSIDE, REFER SERVICING TO QUALIFIED SERVICE PERSONNEL.</p>
	<p>THE LIGHTNING FLASH WITH ARROWHEAD SYMBOL, WITHIN AN EQUILATERAL TRIANGLE, IS INTENDED TO ALERT THE USER TO THE PRESENCE OF UNINSULATED "DANGEROUS VOLTAGE" WITHIN THE PRODUCT'S ENCLOSURE THAT MAY BE OF SUFFICIENT MAGNITUDE TO CONSTITUTE A RISK OF ELECTRIC SHOCK TO PERSONS.</p>	
	<p>THE EXCLAMATION POINT WITHIN AN EQUILATERAL TRIANGLE IS INTENDED TO ALERT THE USER TO THE PRESENCE OF IMPORTANT OPERATING AND MAINTENANCE (SERVICING) INSTRUCTIONS IN THE LITERATURE ACCOMPANYING THE APPLIANCE.</p>	

IMPORTANT SAFEGUARDS

⚠ Caution: Read this page carefully to ensure safe operation.

Please read all of the safety and operating instructions before operating this unit. For best results, follow all warnings placed on the unit and adhere to the operating and use instructions. These safety and operating instructions should be retained for future reference.

1. **Power sources** — The unit should be connected to a power supply only of the type described in the operating instructions or as marked on the appliance.
2. **Power-cord protection** — Power-supply cords should be routed so that they are not likely to be walked on or pinched by items placed upon or against them, pay particular attention to cords at plugs, convenience receptacles, and the point where they exit from the unit.

Never pull or stretch the cord.



3. **Grounding or polarization** — The precautions should be taken so that the grounding or polarization means of this unit is not defeated.

4. **Ventilation** — The unit should be situated so that its location or position does not interfere with its proper ventilation.

To maintain good ventilation, do not put records or a table-cloth on the unit. Place the unit at least 10 cm away from the walls.

Do not use the unit on a bed, sofa, rug or similar surface that may block the ventilation openings.

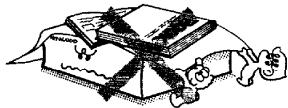

5. **Water and moisture** — The unit should not be used near water — for example, near a bathtub, washbowl, kitchen sink, laundry tub, in a wet basement, or near a swimming pool, etc.

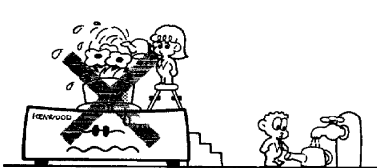

6. **Temperature** — The unit may not function properly if used at extremely low, or freezing temperatures. The ideal ambient temperature is above +5°C (41°F).

7. **Heat** — The unit should be situated away from heat sources such as radiators, heat registers, stoves, or other units (including amplifiers) that produce heat.

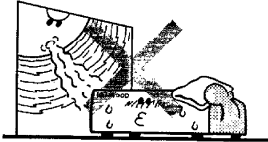

8. **Electric shock** — Care should be taken so that objects do not fall and liquid is not spilled into the enclosure through openings. If a metal object, such as a hair pin or a needle, comes into contact with the inside of this unit, a dangerous electric shock may result. For families with children, never permit children to put anything, especially metal, inside this unit.

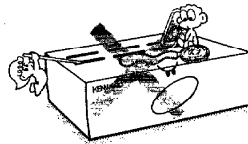

9. **Enclosure removal** — Never remove the enclosure. If the internal parts are touched accidentally, a serious electric shock might occur.

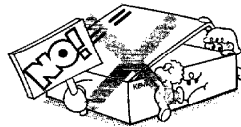

10. **Magnetic fields** — Keep the unit away from sources of magnetic fields such as TV sets, speaker systems, radios, motorized toys or magnetized objects.

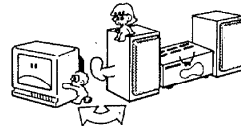

11. **Cleaning** — Do not use volatile solvents such as alcohol, paint thinner, gasoline, or benzine, etc. to clean the cabinet. Use a clean dry cloth.



⚠ Caution: Read this page carefully to ensure safe operation.

- 12. Carts and stands** — An appliance and cart combination should be moved with care. Quick stops, excessive force, and uneven surfaces may cause the appliance and cart combination to overturn.



- 13. Nonuse periods** — The power cord of the unit should be unplugged from the outlet when left unused for a long period of time.

- 14. Abnormal smell** — If an abnormal smell or smoke is detected, immediately turn the power OFF and pull out the power cord. Contact your dealer or nearest service center.

POWER OFF!

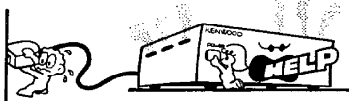

- 15. Damage requiring service** — The unit should be serviced by qualified service personnel when:
- A.** The power-supply cord or the plug has been damaged; or
 - B.** Objects have fallen, or liquid has been spilled into the unit; or
 - C.** The unit has been exposed to rain; or
 - D.** The unit does not appear to operate normally or exhibits a marked change in performance; or
 - E.** The unit has been dropped, or the enclosure damaged.
- 16. Servicing** — The user should not attempt to service the unit beyond that described in the operating instructions. All other servicing should be referred to qualified service personnel.

- 17. Outdoor antenna grounding** — If an outside antenna is connected to the receiver, be sure the antenna system is grounded so as to provide some protection against voltage surges and built up static charges. Section 810 of the National Electrical Code, ANSI/NFPA 70, provides information with respect to proper grounding of the mast and supporting structure, grounding of the lead-in wire to an antenna discharge unit, size of grounding conductors, location of antenna-discharge unit, connection to grounding electrodes, and requirements for the grounding electrode. See Figure.

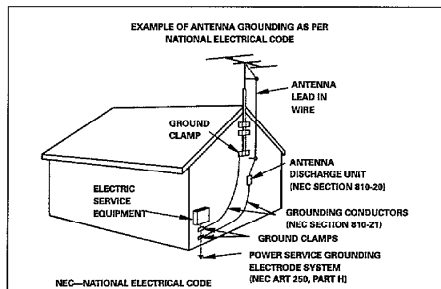

- 18. Power lines** — An outdoor antenna should be located away from power lines.

- 19. AC outlets** — Do not connect other audio equipment with a power consumption larger than that specified to the AC outlet on the rear panel. Never connect other electrical units, such as an iron or toaster, to it to prevent fire or electric shock.

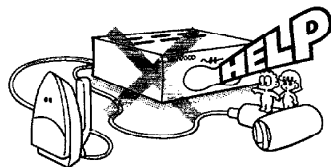

Notes:

1. Item 3 is not required except for grounded or polarized equipment.
2. Item 17 and 18 are not required except for units provided with antenna terminals.
3. Item 17 complies with UL in the U.S.A.

System connections

Make connection as shown below. When connecting the related system components, refer also to the instruction manuals of the related components.
Do not plug in the power lead until all connections are completed.

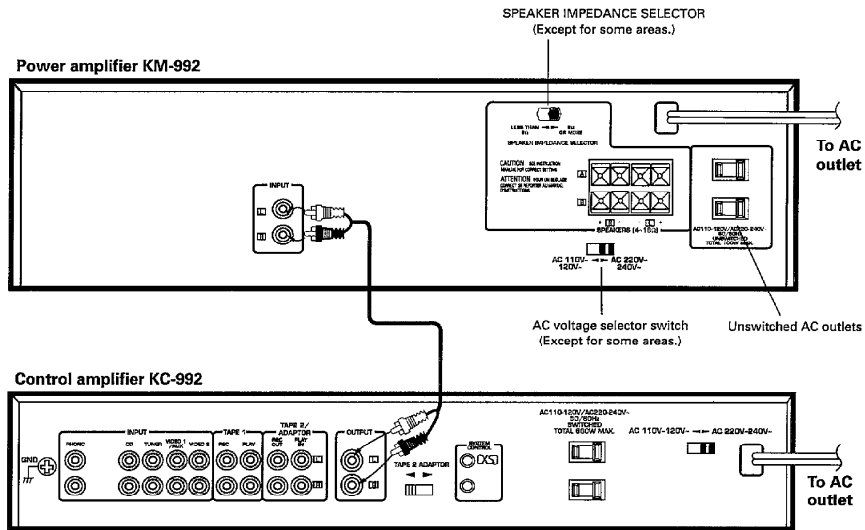

To AC outlet

Unit destination	Shape of the AC outlet
For U.S.A., Canada and U.S. Military	
For Australia	
For other countries	

UNSWITCHED AC outlet

The power of the component connected to this kind of AC outlet can be switched ON/OFF regardless of the POWER key on the main unit.

Notes:

1. Connect all cords firmly. If connections are loose there could be loss of sound or noise produced.
2. When plugging and unplugging connection cords, be sure to first remove the power cord from the AC outlet. Plugging/unplugging connection cords without removal of the power cord can cause malfunctions or damage to the unit.
3. Do not connect up a power source which is larger than that indicated on the socket at the rear of the unit.

■ Connection of speakers

① Push the lever up.



② Insert the cord.



③ Lock the lever.



- Never short-circuit the + and - speaker cords.
- If the left and right speakers are connected inversely or if the speaker cords are connected with reversed polarity, the sound becomes unnatural with ambiguous acoustic image positioning. Be sure to connect the speakers and speaker cords correctly.

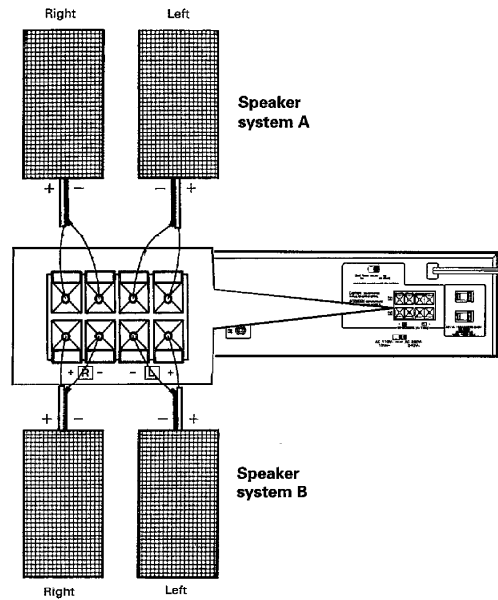

■ Setting the SPEAKER IMPEDANCE SELECTOR (Except for some areas)

Speaker Impedance	Selector position
4 Ω, 6 Ω	"LESS THAN 8 Ω"
8 Ω, 16 Ω	"8 Ω OR MORE"

According to the impedance of the speakers used, set the SPEAKER IMPEDANCE SELECTOR on the rear panel as shown in the table.

- During speaker system connection and operation of the SPEAKER IMPEDANCE SELECTOR, set the POWER key to OFF.
- When only one set of speakers is used, use the SPEAKER A terminals.
- Even when only one of speaker systems A and B uses 4Ω or 6Ω speakers, be sure to set the SPEAKER IMPEDANCE SELECTOR to "LESS THAN 8 Ω".

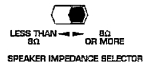

Speaker protection circuit

If the POWER switch of this unit is turned on with the speaker cord short-circuited, the speaker protection circuit will be activated automatically and no sound will be output.

In this case, remove the short circuit of the speaker cord and then turn the POWER switch on again to restore normal operation.

Controls and indicators

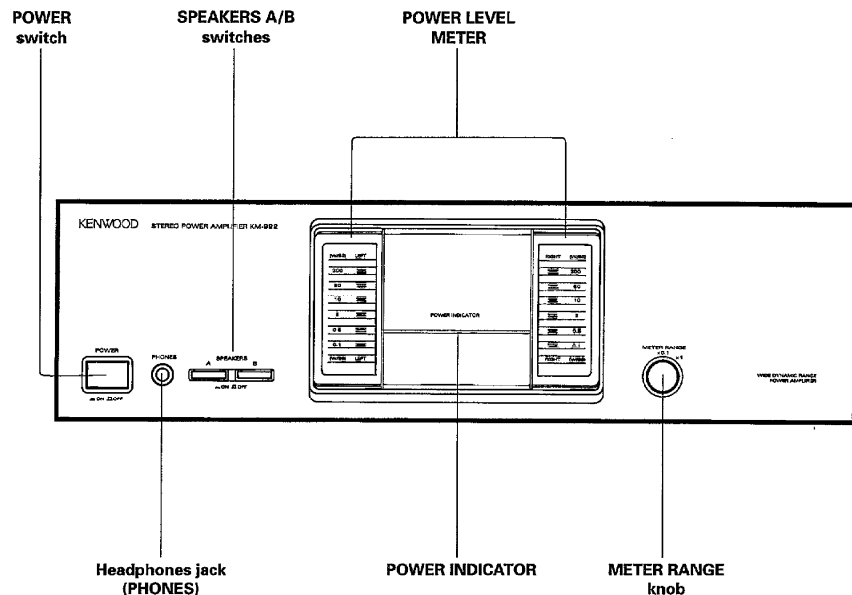

SPEAKERS A and B switches

- A, B OFF** — This position silences all speakers to permit private use of headphones.
 - A ON** — Activates speakers connected to the SPEAKERS A terminals on the rear panel.
 - B ON** — Activates the speakers connected to the SPEAKERS B terminals on the rear panel.
 - A, B ON** — Activates the speakers connected to the SPEAKERS A and B terminals simultaneously.
- When speakers are connected only to the SPEAKERS A terminals, the sound will not be heard if both the SPEAKERS A and B switches are depressed to the ON position.

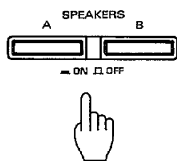

Operating instructions

■ Listening to a program source

1 Switch the power on.



2 Select an input source on the control amplifier.

- The audio signal of that source will be input from the control amplifier connected to this unit.

3 Adjust the volume on the control amplifier.

- The output level is displayed on the POWER LEVEL METER.

4 Adjust the tone on the control amplifier.

■ Listening through headphones

1 Insert the headphone plug into the headphones jack.



- Set the SPEAKERS switch so that both speaker systems A and B are OFF.

2 Adjust the volume on the control amplifier.

- Be sure to minimize the volume before unplugging the headphone plug.

POWER LEVEL METER

The POWER LEVEL METER can display the output power level up to 200 watts. However, it is rather rare that you play music at such high levels as 50 or 200 watts at your home. In usual cases, the meter sensitivity can be boosted by ten times to display the level more finely.

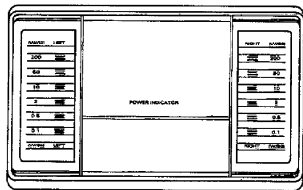

Set the METER RANGE knob to the x0.1 position.



- Levels from 0.01 watt to 200 watts can be displayed.
- To return to the normal sensitivity, set the switch to the x1 position.
- The POWER LEVEL METER displays the levels from 0.1 to 200 watts assuming that the speaker impedance is 8 ohms. If the impedance of your speakers is other than 8 ohms, the POWER LEVEL METER may not display correct values.

In case of difficulty

What appears to be a malfunction may not always be serious. If your unit should not perform as expected, consult the table below to see if the problem can be corrected before seeking help from your dealer or service representative.

Symptom	Cause	Remedy
Power is on but no sound. (Indicator is off.)	<ul style="list-style-type: none">● Poor connection at wall outlet. Power outlet inactive.● Protection circuitry operating.	<ul style="list-style-type: none">● Check outlet using a lamp or other appliance (outlet may be controlled by a wall switch).● Turn the POWER switch OFF, identify and remove the cause, and turn the POWER switch ON again.
Sound is not output. (Indicator lights.)	<ul style="list-style-type: none">● The speaker cords are disconnected.● The VOLUME is set to the minimum position.● Speaker switched off.● Speaker cords are short-circuited.● Audio cords are short-circuited.	<ul style="list-style-type: none">● Connect them properly referring to "System connections".● Adjust the control amplifier's volume to a proper level.● Check speaker switch.● Turn the power off, eliminate the short circuiting, then turn on the power again.
Sound is not output from one of the speakers.	<ul style="list-style-type: none">● The speaker cord is disconnected.● The BALANCE control is set to an extreme position.	<ul style="list-style-type: none">● Connect it properly referring to "System connections".● Adjust the Left/Right balance.

Note:

Do not use contact cleaners because it could cause a malfunction. Be specially careful against contact cleaners containing oil, for they may deform the plastic components.

Specifications

 Caution: Read this page carefully to ensure safe operation.

For U.S.A. and Canada

Rated Power Output

150 watts per channel minimum RMS, both channels driven, at 8 Ω from 20 Hz to 20,000 Hz with no more than 0.03% total harmonic distortion. (FTC)

Total Harmonic Distortion

20 Hz to 20,000 Hz 0.015% at 1/2 rated power into 8 Ω
1 kHz 0.002% at 1/2 rated power into 8 Ω

Inter Modulation Distortion

(60 Hz:7 kHz = 4:1) 0.002% at rated power into 8 Ω

Frequency Response 5 Hz to 200 kHz, +0 dB, -3 dB

Signal-to-Noise Ratio (IHF-A) 120 dB (MAIN IN)

Damping Factor More than 35 at 50 Hz into 8 Ω

General

Power Consumption 5 A

AC outlets

UNSWITCHED 2; (Total 100 W, 0.8 A max.)

Dimensions

W: 440 mm (17-5/8")
H: 133 mm (5-1/4")
D: 276 mm (10-7/8")

Weight (net) 8.6 kg (19.0 lb)

For Other Countries

Rated Power Output

(IHF '66) from 20 Hz to 20,000 Hz

0.03% T.H.D. at 8 Ω 150 W + 150 W

Music Power (8 Ω) 310 W + 310 W

Total Harmonic Distortion

20 Hz to 20,000 Hz 0.015% at 1/2 rated power into 8 Ω
1 kHz 0.002% at 1/2 rated power into 8 Ω

Inter Modulation Distortion

(60 Hz:7 kHz = 4:1) 0.002% at rated power into 8 Ω

Frequency Response 5 Hz to 200 kHz, +0 dB, -3 dB

Signal-to-Noise Ratio (IHF-A) 120 dB (MAIN IN)

Damping Factor More than 35 at 50 Hz into 8 Ω

General

Power Consumption 350 W (IEC)

AC outlets

UNSWITCHED 2; (Total 200 W max.)

Dimensions

W: 440 mm
H: 133 mm
D: 276 mm

Weight (Net) 8.6 kg (19.0 lb)

Note:

KENWOOD follows a policy of continuous advancements in development. For this reason specifications may be changed without notice.

KENWOOD